

Thermowells

for 4350 Econo Thermometers

All dimensions are nominal.
Dimensions in [] are in millimeters.



THERMOWELLS

Standard 2" Stem Length

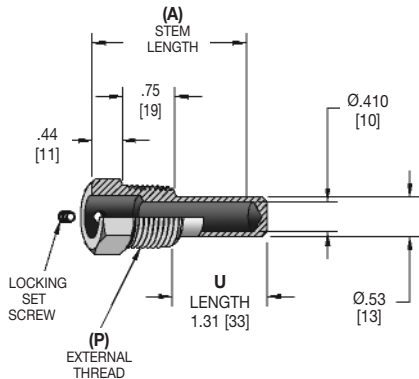

with Lagging Extension 4" Stem Length

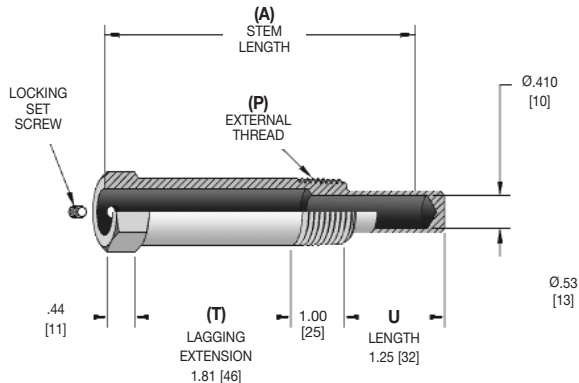

Standard 4" Stem Length

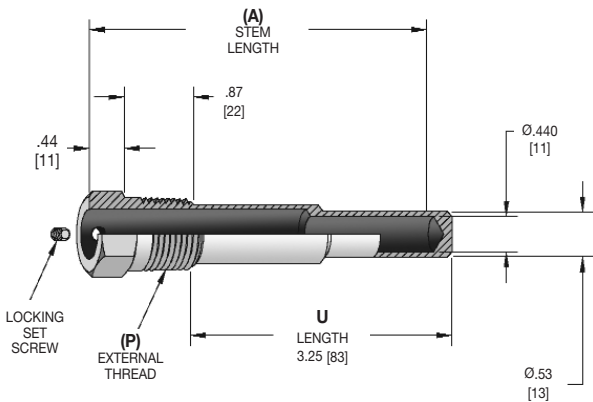

Pressure Rating (psi)

Material	Operating Temperature			
	70°F	200°F	400°F	600°F
Carbon Steel	960	880	750	640
304 Stainless Steel	1200	1100	940	800
316 Stainless Steel	1200	1200	1140	1000
Brass	600 psi @ 150°F, 540 @ 350°F			

Alternative materials and accessories are also available. Please consult the Options and Accessories Section for details.

Selection of the proper thermowell is the sole responsibility of the user. Temperature and pressure limitations must be considered. Improper application may cause failure of the thermowell, resulting in possible personal injury or property damage.

HOW TO ORDER

Sample Order Number: **3-3 C 6**

Thermowell Style	(P) External Thread	(A) Stem Length	(T) Lagging Extension	Material
3- Econo	3 1/2 NPT	C 2" Stem	C 1 3/4 Extension (4" Stem only) Omit if None	2 Brass
	4 3/4 NPT	G 4" Stem		3 Steel
				5 304SS
				6 316SS